

# Cree® XLamp® XH Family LEDs

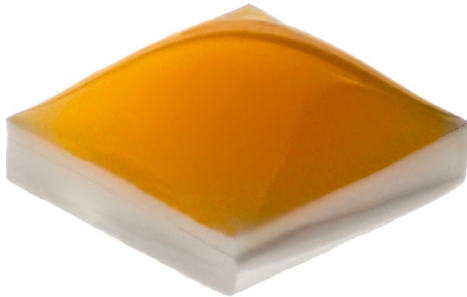

## TABLE OF CONTENTS

Introduction .....	1
Bin and Order-Code Format .....	2
Performance Groups – Luminous Flux .....	2
Performance Groups – Chromaticity .....	3
Cree’s Standard White Chromaticity Regions Plotted on the 1931 CIE Curve .....	6
Cree’s Standard Cool White Kits Plotted on ANSI Standard Chromaticity Regions .....	8
Cree’s Standard Warm and Neutral White Kits Plotted on ANSI Standard Chromaticity Regions .....	9
Cree’s Standard Chromaticity Kits .....	11
Standard Order Codes and Bins	
XH-B ANSI Cool White .....	12
XH-B Neutral White .....	12
XH-B Warm White .....	13
XH-G ANSI Cool White .....	14
XH-G Neutral White .....	14
XH-G Warm White .....	15

## INTRODUCTION

This document describes the product nomenclature required to select and order Cree’s XLamp® XH Family LEDs. XLamp XH Family LEDs are tested and sorted into bins which are then combined into orderable kits identified by an order code.

All XLamp LEDs are tested and sorted by color and brightness into a unique bin. Each bin contains LEDs from only one color and brightness group and is uniquely identified by a bin code. White XLamp LEDs are sorted by chromaticity (color) and luminous flux (brightness). LEDs are shipped on reels containing LEDs from one bin and are always labeled with the appropriate bin code.

Kits contain LEDs from a number of similar bins and are fully defined by their order codes. A full explanation of the order codes for XLamp XH Family LEDs, as well as a list of standard order codes, is provided in this document.

**BIN AND ORDER-CODE FORMAT**

Bin codes and order codes for XH Family White LEDs are configured in the following manner:

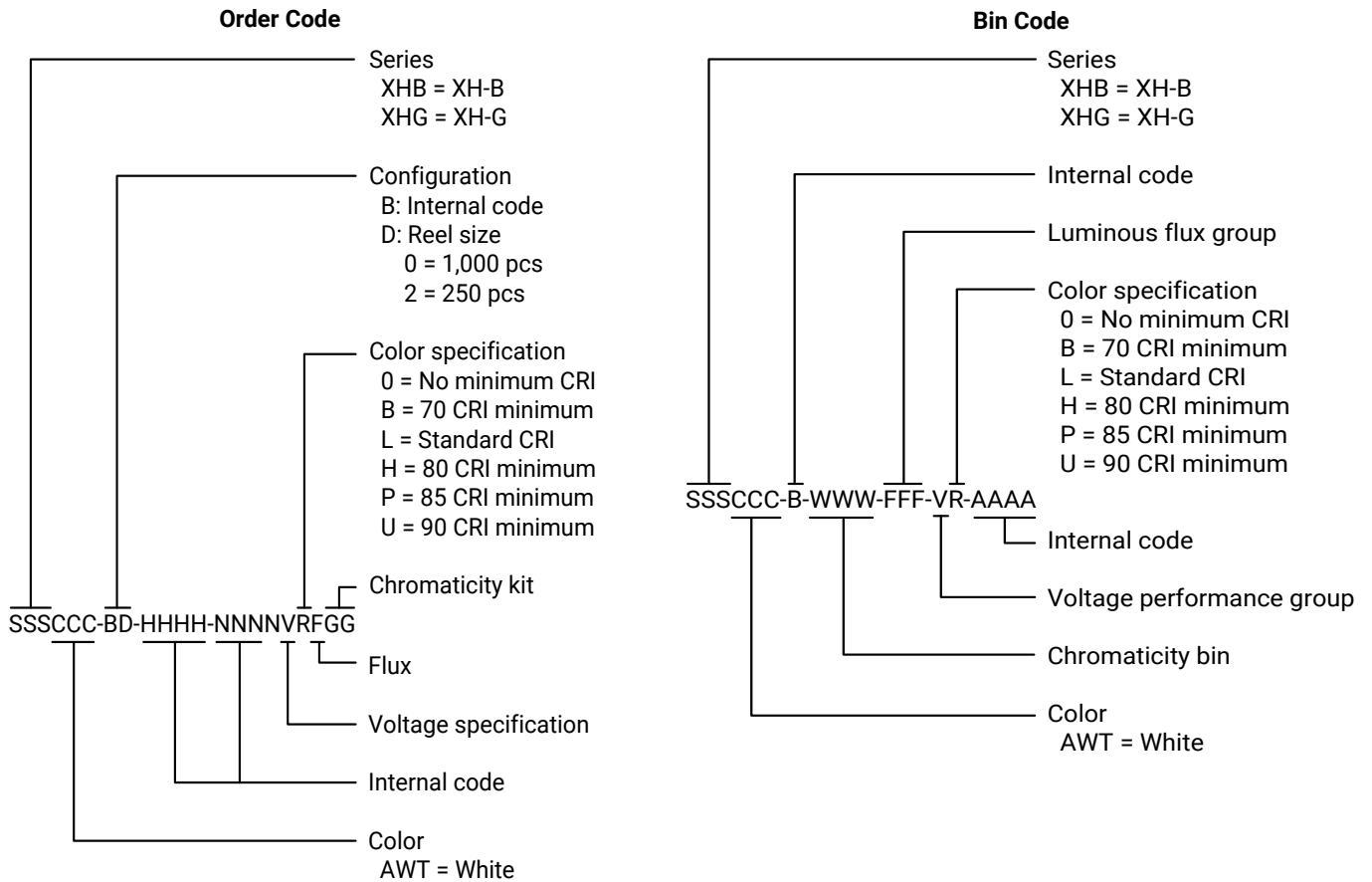

**PERFORMANCE GROUPS – LUMINOUS FLUX (T<sub>j</sub> = 25 °C)**

XLamp XH Family White LEDs are tested for luminous flux and placed into one of the following luminous-flux groups. These group codes, with a 0 appended, are used in the Bin Code “Luminous flux group.”

Group Code	Min. Luminous Flux (lm)	Max. Luminous Flux (lm)
H0	18.1	23.5
J2	23.5	26.8
J3	26.8	30.6
K2	30.6	35.2
K3	35.2	39.8

**PERFORMANCE GROUPS – CHROMATICITY**

XLamp XH Family White LEDs are tested for luminous flux and placed into one of the following chromaticity groups. These group codes are used in the Bin Code “Chromaticity bin.” Two-digit group codes are appended with a 0.

Region	x	y	Region	x	y	Region	x	y	Region	x	y
0A	0.2950	0.2970	0B	0.2920	0.3060	0C	0.2984	0.3133	0D	0.2984	0.3133
	0.2920	0.3060		0.2895	0.3135		0.2962	0.3220		0.3048	0.3207
	0.2984	0.3133		0.2962	0.3220		0.3028	0.3304		0.3068	0.3113
	0.3009	0.3042		0.2984	0.3133		0.3048	0.3207		0.3009	0.3042
0R	0.2980	0.2880	0S	0.2895	0.3135	0T	0.2962	0.3220	0U	0.3037	0.2937
	0.2950	0.2970		0.2870	0.3210		0.2937	0.3312		0.3009	0.3042
	0.3009	0.3042		0.2937	0.3312		0.3005	0.3415		0.3068	0.3113
	0.3037	0.2937		0.2962	0.3220		0.3028	0.3304		0.3093	0.2993
1A	0.3048	0.3207	1B	0.3028	0.3304	1C	0.3115	0.3391	1D	0.3130	0.3290
	0.3130	0.3290		0.3115	0.3391		0.3205	0.3481		0.3213	0.3373
	0.3144	0.3186		0.3130	0.3290		0.3213	0.3373		0.3221	0.3261
	0.3068	0.3113		0.3048	0.3207		0.3130	0.3290		0.3144	0.3186
1R	0.3068	0.3113	1S	0.3005	0.3415	1T	0.3099	0.3509	1U	0.3144	0.3186
	0.3144	0.3186		0.3099	0.3509		0.3196	0.3602		0.3221	0.3261
	0.3161	0.3059		0.3115	0.3391		0.3205	0.3481		0.3231	0.3120
	0.3093	0.2993		0.3028	0.3304		0.3115	0.3391		0.3161	0.3059
2A	0.3215	0.3350	2B	0.3207	0.3462	2C	0.3290	0.3538	2D	0.3290	0.3417
	0.3290	0.3417		0.3290	0.3538		0.3376	0.3616		0.3371	0.3490
	0.3290	0.3300		0.3290	0.3417		0.3371	0.3490		0.3366	0.3369
	0.3222	0.3243		0.3215	0.3350		0.3290	0.3417		0.3290	0.3300
2R	0.3222	0.3243	2S	0.3196	0.3602	2T	0.3290	0.3690	2U	0.3290	0.3300
	0.3290	0.3300		0.3290	0.3690		0.3381	0.3762		0.3366	0.3369
	0.3290	0.3180		0.3290	0.3538		0.3376	0.3616		0.3361	0.3245
	0.3231	0.3120		0.3207	0.3462		0.3290	0.3538		0.3290	0.3180
3A	0.3371	0.3490	3B	0.3376	0.3616	3C	0.3463	0.3687	3D	0.3451	0.3554
	0.3451	0.3554		0.3463	0.3687		0.3551	0.3760		0.3533	0.3620
	0.3440	0.3427		0.3451	0.3554		0.3533	0.3620		0.3515	0.3487
	0.3366	0.3369		0.3371	0.3490		0.3451	0.3554		0.3440	0.3427
3R	0.3366	0.3369	3S	0.3381	0.3762	3T	0.3480	0.3840	3U	0.3440	0.3428
	0.3440	0.3428		0.3480	0.3840		0.3571	0.3907		0.3515	0.3487
	0.3429	0.3307		0.3463	0.3687		0.3551	0.3760		0.3495	0.3339
	0.3361	0.3245		0.3376	0.3616		0.3463	0.3687		0.3429	0.3307
4A	0.3530	0.3597	4B	0.3548	0.3736	4C	0.3641	0.3804	4D	0.3615	0.3659
	0.3615	0.3659		0.3641	0.3804		0.3736	0.3874		0.3702	0.3722
	0.3590	0.3521		0.3615	0.3659		0.3702	0.3722		0.3670	0.3578
	0.3512	0.3465		0.3530	0.3597		0.3615	0.3659		0.3590	0.3521

## PERFORMANCE GROUPS – CHROMATICITY (CONTINUED)

Region	x	y	Region	x	y	Region	x	y	Region	x	y
5A1	0.3670	0.3578	5A2	0.3686	0.3649	5A3	0.3744	0.3685	5A4	0.3726	0.3612
	0.3686	0.3649		0.3702	0.3722		0.3763	0.3760		0.3744	0.3685
	0.3744	0.3685		0.3763	0.3760		0.3825	0.3798		0.3804	0.3721
	0.3726	0.3612		0.3744	0.3685		0.3804	0.3721		0.3783	0.3646
5B1	0.3702	0.3722	5B2	0.3719	0.3797	5B3	0.3782	0.3837	5B4	0.3763	0.3760
	0.3719	0.3797		0.3736	0.3874		0.3802	0.3916		0.3782	0.3837
	0.3782	0.3837		0.3802	0.3916		0.3869	0.3958		0.3847	0.3877
	0.3763	0.3760		0.3782	0.3837		0.3847	0.3877		0.3825	0.3798
5C1	0.3825	0.3798	5C2	0.3847	0.3877	5C3	0.3912	0.3917	5C4	0.3887	0.3836
	0.3847	0.3877		0.3869	0.3958		0.3937	0.4001		0.3912	0.3917
	0.3912	0.3917		0.3937	0.4001		0.4006	0.4044		0.3978	0.3958
	0.3887	0.3836		0.3912	0.3917		0.3978	0.3958		0.3950	0.3875
5D1	0.3783	0.3646	5D2	0.3804	0.3721	5D3	0.3863	0.3758	5D4	0.3840	0.3681
	0.3804	0.3721		0.3825	0.3798		0.3887	0.3836		0.3863	0.3758
	0.3863	0.3758		0.3887	0.3836		0.3950	0.3875		0.3924	0.3794
	0.3840	0.3681		0.3863	0.3758		0.3924	0.3794		0.3898	0.3716
6A1	0.3889	0.3690	6A2	0.3915	0.3768	6A3	0.3981	0.3800	6A4	0.3953	0.3720
	0.3915	0.3768		0.3941	0.3848		0.4010	0.3882		0.3981	0.3800
	0.3981	0.3800		0.4010	0.3882		0.4080	0.3916		0.4048	0.3832
	0.3953	0.3720		0.3981	0.3800		0.4048	0.3832		0.4017	0.3751
6B1	0.3941	0.3848	6B2	0.3968	0.3930	6B3	0.4040	0.3966	6B4	0.4010	0.3882
	0.3968	0.3930		0.3996	0.4015		0.4071	0.4052		0.4040	0.3966
	0.4040	0.3966		0.4071	0.4052		0.4146	0.4089		0.4113	0.4001
	0.4010	0.3882		0.4040	0.3966		0.4113	0.4001		0.4080	0.3916
6C1	0.4080	0.3916	6C2	0.4113	0.4001	6C3	0.4186	0.4037	6C4	0.4150	0.3950
	0.4113	0.4001		0.4146	0.4089		0.4222	0.4127		0.4186	0.4037
	0.4186	0.4037		0.4222	0.4127		0.4299	0.4165		0.4259	0.4073
	0.4150	0.3950		0.4186	0.4037		0.4259	0.4073		0.4221	0.3984
6D1	0.4017	0.3751	6D2	0.4048	0.3832	6D3	0.4116	0.3865	6D4	0.4082	0.3782
	0.4048	0.3832		0.4080	0.3916		0.4150	0.3950		0.4116	0.3865
	0.4116	0.3865		0.4150	0.3950		0.4221	0.3984		0.4183	0.3898
	0.4082	0.3782		0.4116	0.3865		0.4183	0.3898		0.4147	0.3814
7A1	0.4147	0.3814	7A2	0.4183	0.3898	7A3	0.4242	0.3919	7A4	0.4203	0.3833
	0.4183	0.3898		0.4221	0.3984		0.4281	0.4006		0.4242	0.3919
	0.4242	0.3919		0.4281	0.4006		0.4342	0.4028		0.4300	0.3939
	0.4203	0.3833		0.4242	0.3919		0.4300	0.3939		0.4259	0.3853
7B1	0.4221	0.3984	7B2	0.4259	0.4073	7B3	0.4322	0.4096	7B4	0.4281	0.4006
	0.4259	0.4073		0.4299	0.4165		0.4364	0.4188		0.4322	0.4096
	0.4322	0.4096		0.4364	0.4188		0.4430	0.4212		0.4385	0.4119
	0.4281	0.4006		0.4322	0.4096		0.4385	0.4119		0.4342	0.4028

## PERFORMANCE GROUPS – CHROMATICITY (CONTINUED)

Region	x	y	Region	x	y	Region	x	y	Region	x	y
7C1	0.4342	0.4028	7C2	0.4385	0.4119	7C3	0.4449	0.4141	7C4	0.4403	0.4049
	0.4385	0.4119		0.4430	0.4212		0.4496	0.4236		0.4449	0.4141
	0.4449	0.4141		0.4496	0.4236		0.4562	0.4260		0.4513	0.4164
	0.4403	0.4049		0.4449	0.4141		0.4513	0.4164		0.4465	0.4071
7D1	0.4259	0.3853	7D2	0.4300	0.3939	7D3	0.4359	0.3960	7D4	0.4316	0.3873
	0.4300	0.3939		0.4342	0.4028		0.4403	0.4049		0.4359	0.3960
	0.4359	0.3960		0.4403	0.4049		0.4465	0.4071		0.4418	0.3981
	0.4316	0.3873		0.4359	0.3960		0.4418	0.3981		0.4373	0.3893
8A1	0.4373	0.3893	8A2	0.4418	0.3981	8A3	0.4475	0.3994	8A4	0.4428	0.3906
	0.4418	0.3981		0.4465	0.4071		0.4523	0.4085		0.4475	0.3994
	0.4475	0.3994		0.4523	0.4085		0.4582	0.4099		0.4532	0.4008
	0.4428	0.3906		0.4475	0.3994		0.4532	0.4008		0.4483	0.3919
8B1	0.4465	0.4071	8B2	0.4513	0.4164	8B3	0.4573	0.4178	8B4	0.4523	0.4085
	0.4513	0.4164		0.4562	0.4260		0.4624	0.4274		0.4573	0.4178
	0.4573	0.4178		0.4624	0.4274		0.4687	0.4289		0.4634	0.4193
	0.4523	0.4085		0.4573	0.4178		0.4634	0.4193		0.4582	0.4099
8C1	0.4582	0.4099	8C2	0.4634	0.4193	8C3	0.4695	0.4207	8C4	0.4641	0.4112
	0.4634	0.4193		0.4687	0.4289		0.4750	0.4304		0.4695	0.4207
	0.4695	0.4207		0.4750	0.4304		0.4813	0.4319		0.4756	0.4221
	0.4641	0.4112		0.4695	0.4207		0.4756	0.4221		0.4700	0.4126
8D1	0.4483	0.3919	8D2	0.4532	0.4008	8D3	0.4589	0.4021	8D4	0.4538	0.3931
	0.4532	0.4008		0.4582	0.4099		0.4641	0.4112		0.4589	0.4021
	0.4589	0.4021		0.4641	0.4112		0.4700	0.4126		0.4646	0.4034
	0.4538	0.3931		0.4589	0.4021		0.4646	0.4034		0.4593	0.3944
AA1	0.4822	0.3973	AA2	0.4884	0.4067	AA3	0.4942	0.4066	AA4	0.4879	0.3972
	0.4884	0.4067		0.4946	0.4162		0.5006	0.4160		0.4942	0.4066
	0.4942	0.4066		0.5006	0.4160		0.5066	0.4158		0.5001	0.4064
	0.4879	0.3972		0.4942	0.4066		0.5001	0.4064		0.4936	0.3970
AB1	0.4946	0.4162	AB2	0.5008	0.4256	AB3	0.5069	0.4254	AB4	0.5006	0.4160
	0.5008	0.4256		0.5070	0.4350		0.5133	0.4348		0.5069	0.4254
	0.5069	0.4254		0.5133	0.4348		0.5196	0.4346		0.5131	0.4252
	0.5006	0.4160		0.5069	0.4254		0.5131	0.4252		0.5066	0.4158
AC1	0.5066	0.4067	AC2	0.5131	0.4252	AC3	0.5192	0.4250	AC4	0.5126	0.4156
	0.5131	0.4162		0.5196	0.4346		0.5258	0.4343		0.5192	0.4250
	0.5192	0.4160		0.5258	0.4343		0.5321	0.4341		0.5253	0.4248
	0.5126	0.4066		0.5192	0.4250		0.5253	0.4248		0.5186	0.4154
AD1	0.4936	0.3970	AD2	0.5001	0.4064	AD3	0.5059	0.4062	AD4	0.4993	0.3969
	0.5001	0.4064		0.5066	0.4158		0.5126	0.4156		0.5059	0.4062
	0.5059	0.4062		0.5126	0.4156		0.5186	0.4154		0.5118	0.4061
	0.4993	0.3969		0.5059	0.4062		0.5118	0.4061		0.5050	0.3967

**CREE'S STANDARD WHITE CHROMATICITY REGIONS PLOTTED ON THE 1931 CIE CURVE**

**ANSI Cool White**

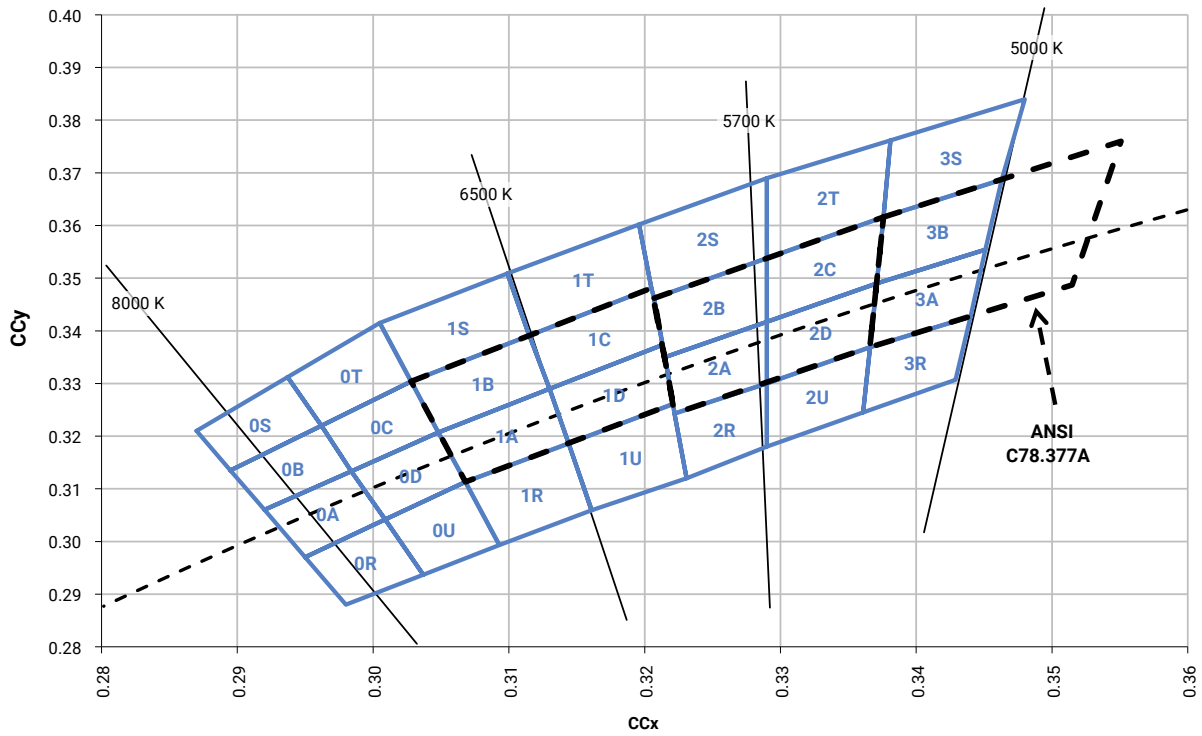

**ANSI Neutral White and ANSI Warm White**

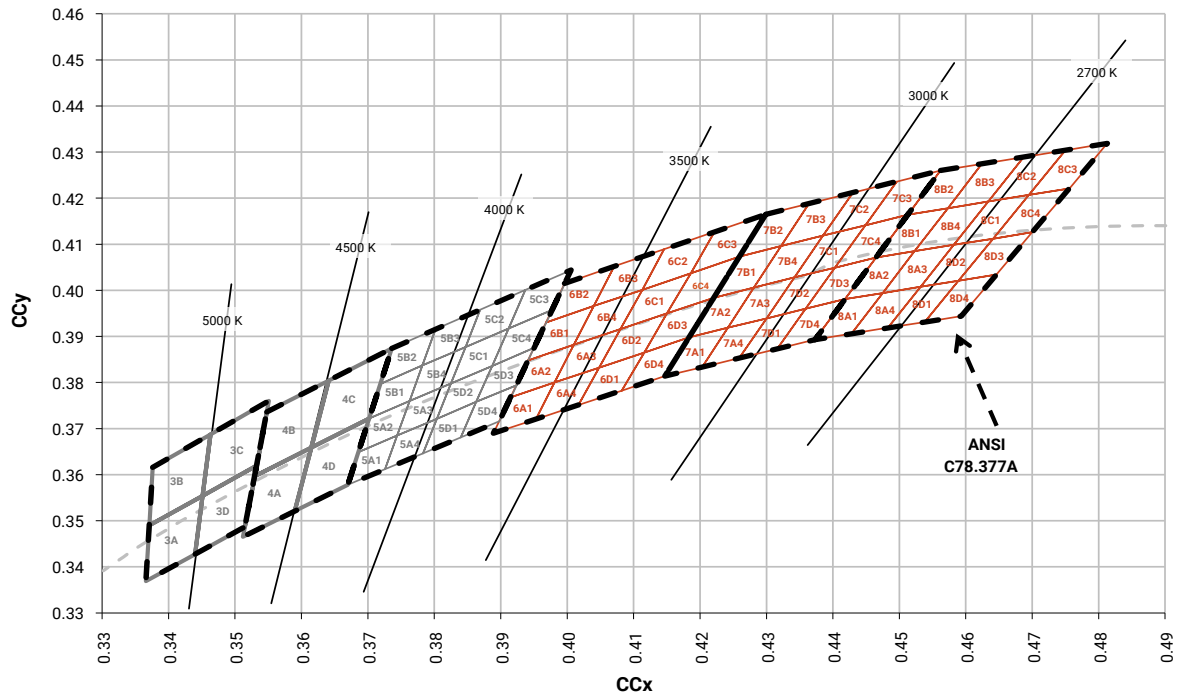

**CREE'S STANDARD WHITE CHROMATICITY REGIONS PLOTTED ON THE 1931 CIE CURVE - CONTINUED**

**ANSI Neutral White and ANSI Warm White - Continued**

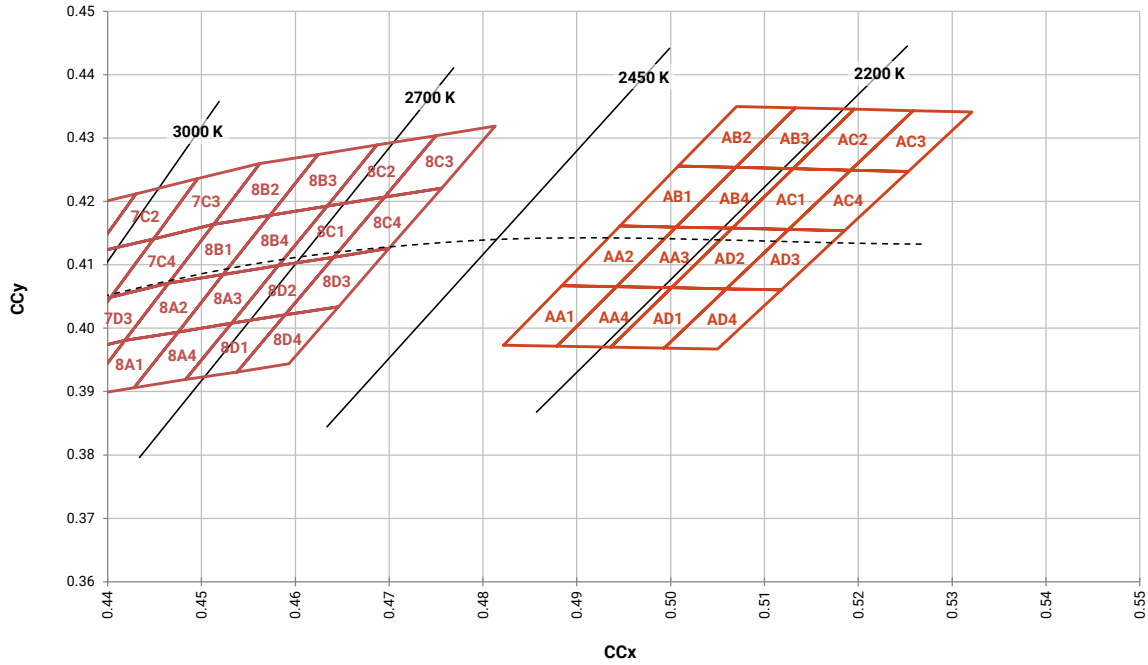

**CREE'S STANDARD COOL WHITE KITS PLOTTED ON ANSI STANDARD CHROMATICITY REGIONS**

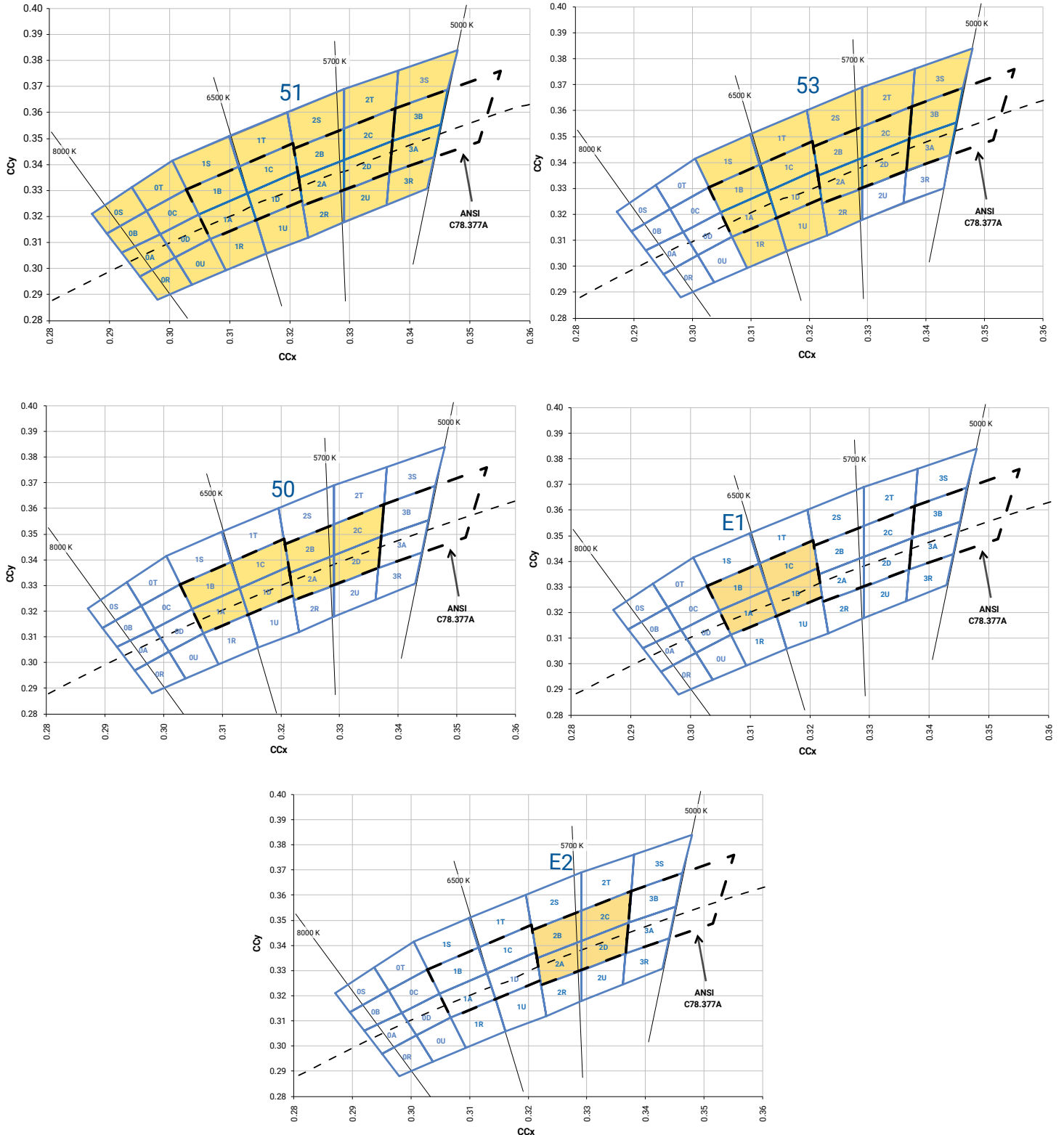



**CREE'S STANDARD WARM AND NEUTRAL WHITE KITS PLOTTED ON ANSI STANDARD CHROMATICITY REGIONS**

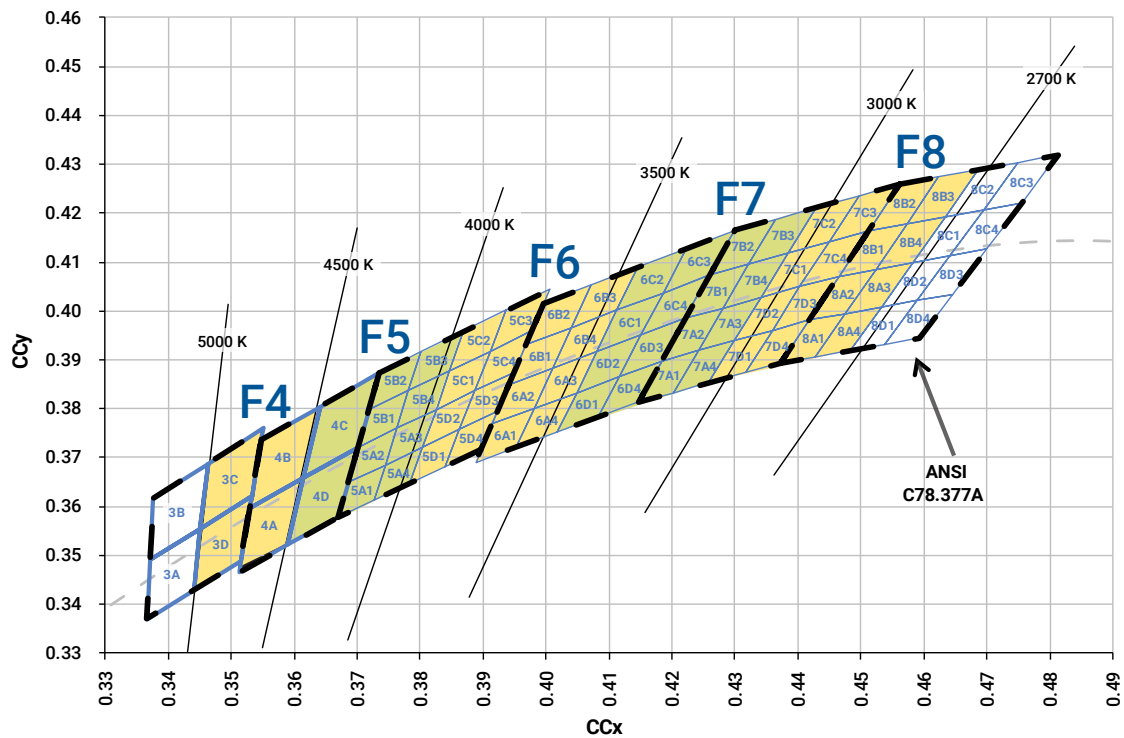
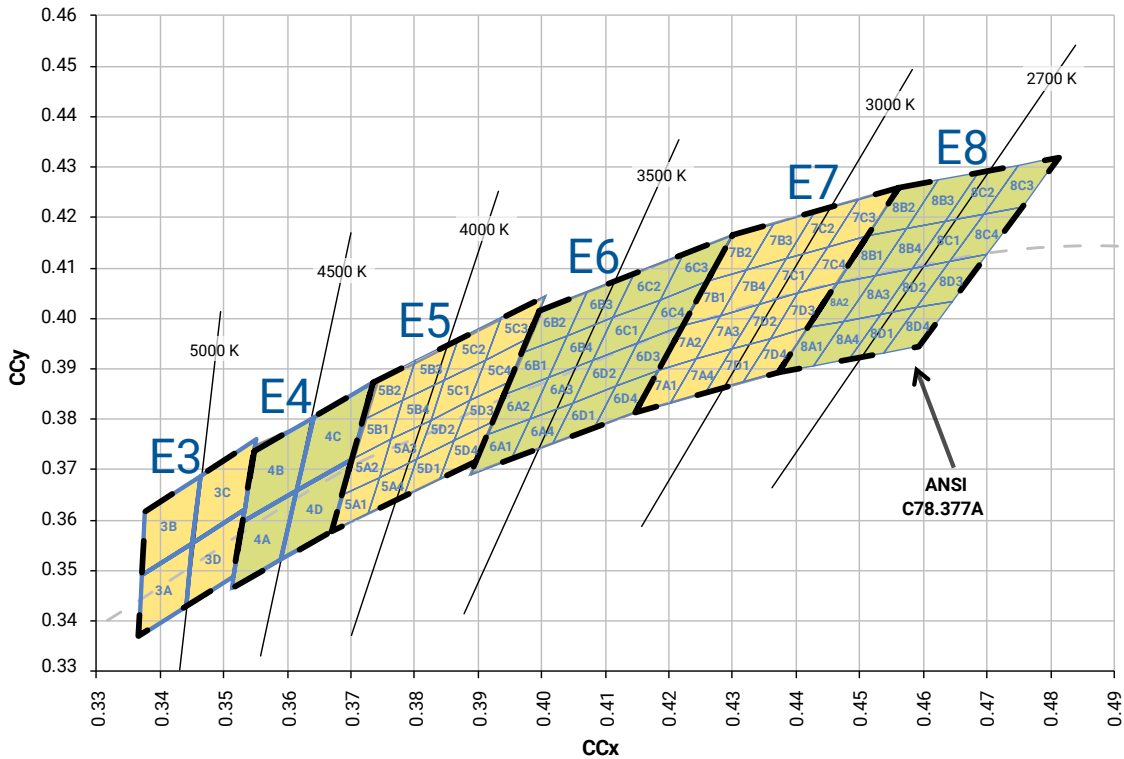

**CREE'S STANDARD WARM AND NEUTRAL WHITE KITS PLOTTED ON ANSI STANDARD CHROMATICITY REGIONS - CONTINUED**

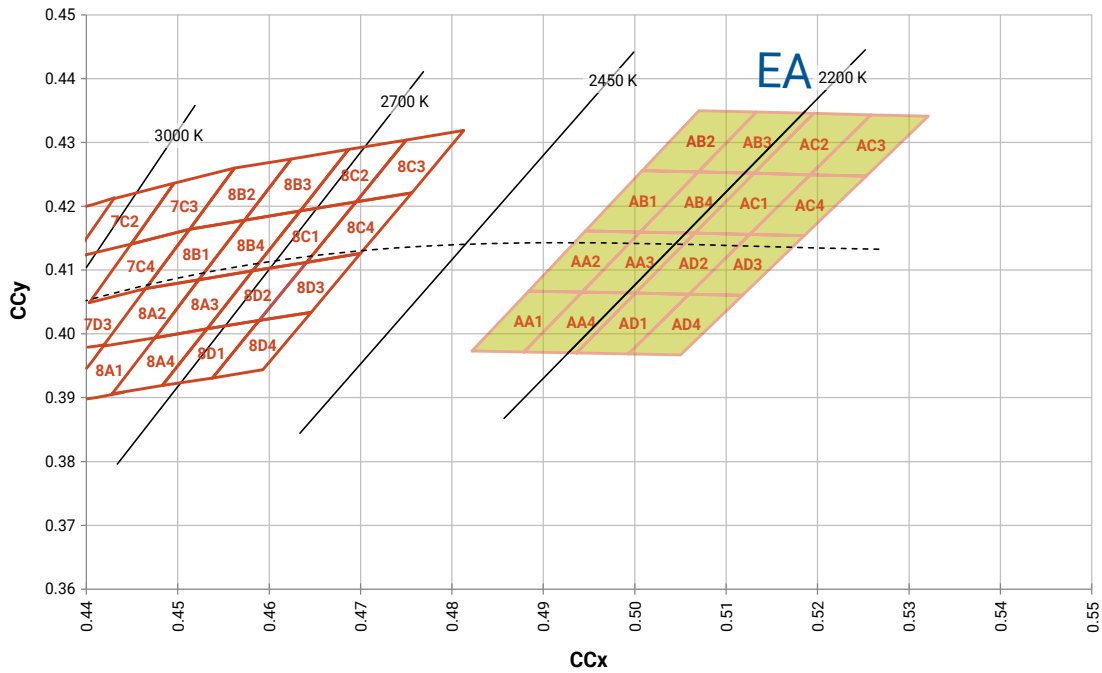

## CREE'S STANDARD CHROMATICITY KITS

The following table provides the chromaticity bins associated with chromaticity kits.

Color	CCT	Kit	Chromaticity Bins
Cool White	6200 K	51	0A, 0B, 0C, 0D, 0R, 0S, 0T, 0U, 1A, 1B, 1C, 1D, 1R, 1S, 1T, 1U, 2A, 2B, 2C, 2D, 2R, 2S, 2T, 2U, 3A, 3B, 3R, 3S
	6000 K	53	1A, 1B, 1C, 1D, 1R, 1S, 1T, 1U, 2A, 2B, 2C, 2D, 2R, 2S, 2T, 3A, 3B, 3S
	6200 K	50	1A, 1B, 1C, 1D, 2A, 2B, 2C, 2D
	6500 K	E1	1A, 1B, 1C, 1D
	5700 K	E2	2A, 2B, 2C, 2D
Neutral White	5000 K	E3	3A, 3B, 3C, 3D
	4750 K	F4	3C, 3D, 4A, 4B
	4500 K	E4	4A, 4B, 4C, 4D
	4250 K	F5	4C, 4D, 5A1, 5A2, 5A3, 5A4, 5B1, 5B2, 5B3, 5B4
	4000 K	E5	5A1, 5A2, 5A3, 5A4, 5B1, 5B2, 5B3, 5B4, 5C1, 5C2, 5C3, 5C4, 5D1, 5D2, 5D3, 5D4
Warm White	3750 K	F6	5C1, 5C2, 5C3, 5C4, 5D1, 5D2, 5D3, 5D4, 6A1, 6A2, 6A3, 6A4, 6B1, 6B2, 6B3, 6B4
	3500 K	E6	6A1, 6A2, 6A3, 6A4, 6B1, 6B2, 6B3, 6B4, 6C1, 6C2, 6C3, 6C4, 6D1, 6D2, 6D3, 6D4
	3250 K	F7	6C1, 6C2, 6C3, 6C4, 6D1, 6D2, 6D3, 6D4, 7A1, 7A2, 7A3, 7A4, 7B1, 7B2, 7B3, 7B4
	3000 K	E7	7A1, 7A2, 7A3, 7A4, 7B1, 7B2, 7B3, 7B4, 7C1, 7C2, 7C3, 7C4, 7D1, 7D2, 7D3, 7D4
	2850 K	F8	7C1, 7C2, 7C3, 7C4, 7D1, 7D2, 7D3, 7D4, 8A1, 8A2, 8A3, 8A4, 8B1, 8B2, 8B3, 8B4
	2700 K	E8	8A1, 8A2, 8A3, 8A4, 8B1, 8B2, 8B3, 8B4, 8C1, 8C2, 8C3, 8C4, 8D1, 8D2, 8D3, 8D4
	2200 K	EA	AA1, AA2, AA3, AA4, AB1, AB2, AB3, AB4, AC1, AC2, AC3, AC4, AD1, AD2, AD3, AD4

The following tables of order codes list flux minimums and chromaticity regions for the various categories of XLamp XH LEDs. For other flux and chromaticity combinations, contact Cree or an authorized distributor.

**STANDARD ORDER CODES AND BINS (XH-B ANSI COOL WHITE,  $T_j = 25^\circ\text{C}$ )**

XLamp XH-B LED Standard Kit Codes - White						
Chromaticity		Minimum Luminous Flux (lm) @ 65 mA		Order Codes		
Kit	CCT	Code	Flux (lm)	No Minimum CRI	70 CRI Minimum	80 CRI Minimum
ANSI Cool White (5000 K – 8300 K)						
E1	6500 K	J3	26.8	XHBAWT-00-0000-00000LXE1	XHBAWT-00-0000-00000BXE1	XHBAWT-00-0000-00000HXE1
		J2	23.5			XHBAWT-00-0000-00000HWE1
50	6000 K	J3	26.8	XHBAWT-00-0000-00000LX50	XHBAWT-00-0000-00000BX50	XHBAWT-00-0000-00000HX50
		J2	23.5			XHBAWT-00-0000-00000HW50
51	6000 K	J3	26.8	XHBAWT-00-0000-00000LX51	XHBAWT-00-0000-00000BX51	XHBAWT-00-0000-00000HX51
		J2	23.5			XHBAWT-00-0000-00000HW51
53	5700 K	J3	26.8	XHBAWT-00-0000-00000LX53	XHBAWT-00-0000-00000BX53	XHBAWT-00-0000-00000HX53
		J2	23.5			XHBAWT-00-0000-00000HW53
E2	5700 K	J3	26.8	XHBAWT-00-0000-00000LXE2	XHBAWT-00-0000-00000BXE2	XHBAWT-00-0000-00000HXE2
		J2	23.5			XHBAWT-00-0000-00000HWE2

**STANDARD ORDER CODES AND BINS (XH-B NEUTRAL WHITE,  $T_j = 25^\circ\text{C}$ )**

XLamp XH-B LED Standard Kit Codes - White						
Chromaticity		Minimum Luminous Flux (lm) @ 65 mA		Order Codes		
Kit	CCT	Code	Flux (lm)	70 CRI Minimum	75 CRI Typical	80 CRI Minimum
ANSI Neutral White (3700 K – 5000 K)						
E3	5000 K	J3	26.8	XHBAWT-00-0000-00000BXE3	XHBAWT-00-0000-00000LXE3	XHBAWT-00-0000-00000HXE3
		J2	23.5			XHBAWT-00-0000-00000HWE3
F4	4750 K	J3	26.8	XHBAWT-00-0000-00000BXF4	XHBAWT-00-0000-00000LXF4	XHBAWT-00-0000-00000HXF4
		J2	23.5			XHBAWT-00-0000-00000HWF4
E4	4500 K	J3	26.8	XHBAWT-00-0000-00000BXE4	XHBAWT-00-0000-00000LXE4	XHBAWT-00-0000-00000HXE4
		J2	23.5			XHBAWT-00-0000-00000HWE4
F5	4300 K	J3	26.8	XHBAWT-00-0000-00000BXF5	XHBAWT-00-0000-00000LXF5	XHBAWT-00-0000-00000HXF5
		J2	23.5		XHBAWT-00-0000-00000LWF5	XHBAWT-00-0000-00000HWF5
E5	4000 K	J3	26.8	XHBAWT-00-0000-00000BXE5	XHBAWT-00-0000-00000LXE5	XHBAWT-00-0000-00000HXE5
		J2	23.5	XHBAWT-00-0000-00000BWE5	XHBAWT-00-0000-00000LWE5	XHBAWT-00-0000-00000HWE5

**Notes:**

- Cree maintains a tolerance of  $\pm 7\%$  on flux and power measurements,  $\pm 0.005$  on chromaticity (CCx, CCy) measurements and  $\pm 2$  on CRI measurements.
- Cree XLamp XH Family LED order codes specify only a minimum flux bin and not a maximum. Cree may ship reels in flux bins higher than the minimum specified by the order code without advance notice. Shipments will always adhere to the chromaticity or DWL bin restrictions specified by the order code.

STANDARD ORDER CODES AND BINS (XH-B WARM WHITE, T<sub>j</sub> = 25 °C)

XLamp XH-B LED Standard Kit Codes - White								
Chromaticity		Minimum Luminous Flux (lm) @ 65 mA		Order Codes				
Kit	CCT	Code	Flux (lm)	70 CRI Minimum	80 CRI Typical	80 CRI Minimum	85 CRI Minimum	90 CRI Minimum
ANSI Warm White (2700 K - 3700 K)								
F6	3700 K	J3	26.8	XHBAWT-00-0000-00000BXF6				
		J2	23.5	XHBAWT-00-0000-00000BWF6	XHBAWT-00-0000-00000LWF6	XHBAWT-00-0000-00000HWF6		
E6	3500 K	J3	26.8	XHBAWT-00-0000-00000BXE6				
		J2	23.5	XHBAWT-00-0000-00000BWE6	XHBAWT-00-0000-00000LWE6	XHBAWT-00-0000-00000HWE6		
F7	3200 K	J3	26.8	XHBAWT-00-0000-00000BXF7				
		J2	23.5	XHBAWT-00-0000-00000BWF7	XHBAWT-00-0000-00000LWF7	XHBAWT-00-0000-00000HWF7		
		H0	18.1				XHBAWT-00-0000-00000PVF7	XHBAWT-00-0000-00000UVF7
E7	3000 K	J3	26.8	XHBAWT-00-0000-00000BXE7				
		J2	23.5	XHBAWT-00-0000-00000BWE7	XHBAWT-00-0000-00000LWE7	XHBAWT-00-0000-00000HWE7		
		H0	18.1				XHBAWT-00-0000-00000PVE7	XHBAWT-00-0000-00000UVE7
F8	2850 K	J2	23.5	XHBAWT-00-0000-00000BWF8	XHBAWT-00-0000-00000LWF8	XHBAWT-00-0000-00000HWF8		
		H0	18.1				XHBAWT-00-0000-00000PVF8	XHBAWT-00-0000-00000UVF8
E8	2700 K	J2	23.5	XHBAWT-00-0000-00000BWE8	XHBAWT-00-0000-00000LWE8	XHBAWT-00-0000-00000HWE8		
		H0	18.1				XHBAWT-00-0000-00000PVE8	XHBAWT-00-0000-00000UVE8

## Notes:

- Cree maintains a tolerance of  $\pm 7\%$  on flux and power measurements,  $\pm 0.005$  on chromaticity (CCx, CCy) measurements and  $\pm 2$  on CRI measurements.
- Cree XLamp XH Family LED order codes specify only a minimum flux bin and not a maximum. Cree may ship reels in flux bins higher than the minimum specified by the order code without advance notice. Shipments will always adhere to the chromaticity or DWL bin restrictions specified by the order code.

**STANDARD ORDER CODES AND BINS (XH-G ANSI COOL WHITE,  $T_j = 25^\circ\text{C}$ )**

XLamp XH-G LED Standard Kit Codes - White						
Chromaticity		Minimum Luminous Flux (lm) @ 65 mA		Order Codes		
Kit	CCT	Code	Flux (lm)	No Minimum CRI	70 CRI Minimum	80 CRI Minimum
ANSI Cool White (5000 K – 8300 K)						
E1	6500 K	K2	30.6	XHGAWT-00-0000-00000L0E1	XHGAWT-00-0000-00000B0E1	
		J3	26.8	XHGAWT-00-0000-00000LXE1	XHGAWT-00-0000-00000BXE1	XHGAWT-00-0000-00000HXE1
50	6000 K	K2	30.6	XHGAWT-00-0000-00000L050	XHGAWT-00-0000-00000B050	
		J3	26.8	XHGAWT-00-0000-00000LX50	XHGAWT-00-0000-00000BX50	XHGAWT-00-0000-00000HX50
51	6000 K	K2	30.6	XHGAWT-00-0000-00000L051	XHGAWT-00-0000-00000B051	
		J3	26.8	XHGAWT-00-0000-00000LX51	XHGAWT-00-0000-00000BX51	XHGAWT-00-0000-00000HX51
53	5700 K	K2	30.6	XHGAWT-00-0000-00000L053	XHGAWT-00-0000-00000B053	
		J3	26.8	XHGAWT-00-0000-00000LX53	XHGAWT-00-0000-00000BX53	XHGAWT-00-0000-00000HX53
E2	5700 K	K2	30.6	XHGAWT-00-0000-00000L0E2	XHGAWT-00-0000-00000B0E2	
		J3	26.8	XHGAWT-00-0000-00000LXE2	XHGAWT-00-0000-00000BXE2	XHGAWT-00-0000-00000HXE2

**STANDARD ORDER CODES AND BINS (XH-G NEUTRAL WHITE,  $T_j = 25^\circ\text{C}$ )**

XLamp XH-G LED Standard Kit Codes - White						
Chromaticity		Minimum Luminous Flux (lm) @ 65 mA		Order Codes		
Kit	CCT	Code	Flux (lm)	70 CRI Minimum	75 CRI Typical	80 CRI Minimum
ANSI Neutral White (3700 K – 5000 K)						
E3	5000 K	K2	30.6	XHGAWT-00-0000-00000B0E3	XHGAWT-00-0000-00000L0E3	
		J3	26.8	XHGAWT-00-0000-00000BXE3	XHGAWT-00-0000-00000LXE3	XHGAWT-00-0000-00000HXE3
F4	4750 K	K2	30.6	XHGAWT-00-0000-00000B0F4		
		J3	26.8	XHGAWT-00-0000-00000BXF4	XHGAWT-00-0000-00000LXF4	XHGAWT-00-0000-00000HXF4
E4	4500 K	K2	30.6	XHGAWT-00-0000-00000B0E4		
		J3	26.8	XHGAWT-00-0000-00000BXE4	XHGAWT-00-0000-00000LXE4	XHGAWT-00-0000-00000HXE4
F5	4300 K	K2	30.6	XHGAWT-00-0000-00000B0F5		
		J3	26.8	XHGAWT-00-0000-00000BXF5	XHGAWT-00-0000-00000LXF5	XHGAWT-00-0000-00000HXF5
E5	4000 K	K2	30.6	XHGAWT-00-0000-00000B0E5		XHGAWT-00-0000-00000H0E5
		J3	26.8	XHGAWT-00-0000-00000BXE5	XHGAWT-00-0000-00000LXE5	XHGAWT-00-0000-00000HXE5

**Notes:**

- Cree maintains a tolerance of  $\pm 7\%$  on flux and power measurements,  $\pm 0.005$  on chromaticity (CCx, CCy) measurements and  $\pm 2$  on CRI measurements.
- Cree XLamp XH Family LED order codes specify only a minimum flux bin and not a maximum. Cree may ship reels in flux bins higher than the minimum specified by the order code without advance notice. Shipments will always adhere to the chromaticity or DWL bin restrictions specified by the order code.

STANDARD ORDER CODES AND BINS (XH-G WARM WHITE, T<sub>j</sub> = 25 °C)

XLamp XH-G LED Standard Kit Codes - White								
Chromaticity		Minimum Luminous Flux (lm) @ 65 mA		Order Codes				
Kit	CCT	Code	Flux (lm)	70 CRI Minimum	80 CRI Typical	80 CRI Minimum	85 CRI Minimum	90 CRI Minimum
ANSI Warm White (2700 K - 3700 K)								
F6	3700 K	J3	26.8	XHGAWT-00-0000-00000BXF6	XHGAWT-00-0000-00000LXF6	XHGAWT-00-0000-00000HXF6		
E6	3500 K	J3	26.8	XHGAWT-00-0000-00000BXE6	XHGAWT-00-0000-00000LXE6	XHGAWT-00-0000-00000HXE6		
F7	3200 K	J3	26.8	XHGAWT-00-0000-00000BXF7	XHGAWT-00-0000-00000LXF7	XHGAWT-00-0000-00000HXF7		
		J2	23.5			XHGAWT-00-0000-00000HWF7		
		H0	18.1				XHGAWT-00-0000-00000PVF7	XHGAWT-00-0000-00000UVF7
E7	3000 K	J3	26.8	XHGAWT-00-0000-00000BXE7	XHGAWT-00-0000-00000LXE7	XHGAWT-00-0000-00000HXE7		
		J2	23.5			XHGAWT-00-0000-00000HWE7		
		H0	18.1				XHGAWT-00-0000-00000PVE7	XHGAWT-00-0000-00000UVE7
F8	2850 K	J3	26.8	XHGAWT-00-0000-00000BXF8	XHGAWT-00-0000-00000LXF8	XHGAWT-00-0000-00000HXF8		
		J2	23.5		XHGAWT-00-0000-00000LWF8	XHGAWT-00-0000-00000HWF8		
		H0	18.1				XHGAWT-00-0000-00000PVF8	XHGAWT-00-0000-00000UVF8
E8	2700 K	J3	26.8	XHGAWT-00-0000-00000BXE8	XHGAWT-00-0000-00000LXE8	XHGAWT-00-0000-00000HXE8		
		J2	23.5		XHGAWT-00-0000-00000LWE8	XHGAWT-00-0000-00000HWE8		
		H0	18.1				XHGAWT-00-0000-00000PVE8	XHGAWT-00-0000-00000UVE8

## Notes:

- Cree maintains a tolerance of  $\pm 7\%$  on flux and power measurements,  $\pm 0.005$  on chromaticity (CCx, CCy) measurements and  $\pm 2$  on CRI measurements.
- Cree XLamp XH Family LED order codes specify only a minimum flux bin and not a maximum. Cree may ship reels in flux bins higher than the minimum specified by the order code without advance notice. Shipments will always adhere to the chromaticity or DWL bin restrictions specified by the order code.